

Data Sheet



Article number: 588Q2C440XE0666

Description: Solenoid valve type Q2C440.XE0.666 2/2 NC
12 VDC orifice 4,0 housing in Stainless AISI 316 Inlet port G1/4"

Measures

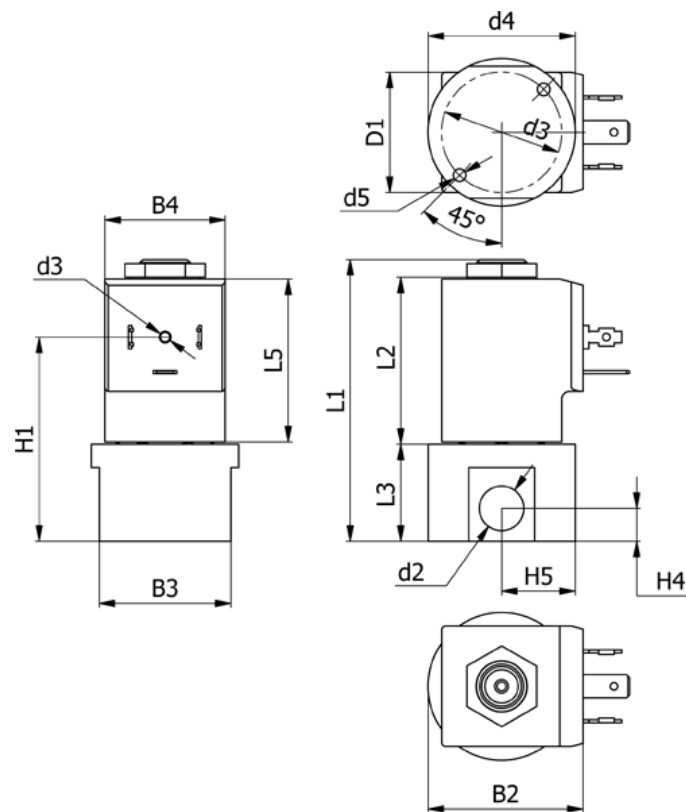

B2 = 40	H1 = 52.5	Voltage = 12 VDC
B3 = 34	H4 = 8.5	
B4 = 31	H5 = 19	
d2 = G1/4"	L1 = 72.6	
d3 = M3x4	L3 = 25	
d4 = 31	L5 = 42.5	
d5 = M4x8	Orifice = 4.0	
Flow = 7.5	Valve function = 2/2 NC	